

FLAWTECH

The World Leader in Flaw Manufacturing Technology



Specimen Catalogue

704.795.4401

www.FlawTech.com

TABLE of CONTENTS

1	FLAWED SPECIMEN CATEGORIES
2	FLAWTECH DISCONTINUITIES LIST
3	FLAW CROSS SECTION VIEWS
4	FLAW CROSS SECTION VIEWS
5	STANDARD KITS
6	STANDARD RADIOGRAPHIC KIT
7	STANDARD MAGNETIC PARTICLE / LIQUID PENETRANT KIT
8	STANDARD ULTRASONIC KIT
9	NDT DEMONSTRATION KIT
10	STANDARD VISUAL KIT
11	MULTI METHOD KIT
12	CAST SAMPLE SET
13	PRACTICAL EXAM SPECIMENS
14	ULTRASONIC PRACTICAL EXAM SPECIMENS
15	MT/PT & VT PRACTICAL EXAM SPECIMENS
16	ADVANCED SPECIMENS
17	ADVANCED SPECIMENS
18	ADVANCED SPECIMENS
19	CORROSION, EROSION, & LAMINATION PLATES
20	FLAWTECH BUBBLE LEAK KIT
21	API CRACK SIZING BARS
22	API-UT-1 FLAWED SPECIMEN KIT
23	API-UT-MINI KIT
24	API-RP-2X SPECIMEN KIT
25	FLAWTECH AWS D1.5 UT BRIDGE KIT
26	FLAWTECH RT "STACKED" KIT
27	AWS/CWI VISUAL SPECIMEN KIT
28	TRAVELER CWI VISUAL TRAINING KIT
29	AWS/CWI PLUS PT ENDORSEMENT KIT
30	AWS STRUCTURAL WELD SEISMIC KIT
31	SOCKET WELD SPECIMEN KIT
32	BORESCOPE SAMPLE SET
32	BOILER TUBE DAMAGE KIT
33	ASME SECTION XI APPENDIX VII KIT
34	ASME SECTION XI APPENDIX VIII KITS
35	EISHIN NiCr TWIN CRACKED PENETRANT TEST PANELS
36	ALUMINUM PENETRANT COMPARATOR BLOCK
37	UT CALIBRATION BLOCKS
38	PDI UT CALIBRATION BLOCKS
39	ASME UT CALIBRATION STANDARDS
40	PDI UT 10 CALIIBRATION BLOCKS

FLAWED SPECIMEN CATEGORIES

STANDARD SPECIMEN

- Have a tolerance of $\pm 0.150"$ (4mm).
- Includes all standard kit specimens and all UT & MT / PT practical exam specimens.
- Designed to enhance the training and development of new and veteran NDT technicians.
- Normally smaller in size and less expensive than Advanced and Critical specimens.
- Basic Document Package with CAD drawings is included with each kit or exam specimen.
- Custom specimens are available at this level of tolerance.

ADVANCED SPECIMEN

- Have a tolerance of $\pm 0.080"$ (2mm).
- Includes all advanced specimens, API-UT-1 kit & all ASME section XI appendix VII specimen bank.
- Designed to enhance the training & qualification of level I, II, & III personnel with regards to SNT-TC-1 A, EN473 & PCN.
- Stock Advanced Specimens are larger in size than the standard specimen and higher tolerance.
- Document package with CAD drawings is included with each kit or individual Advanced Specimen.
- Custom specimens are available at this level of tolerance.

CRITICAL SPECIMEN

- Have a tolerance of $\pm 0.040"$ (1mm).
- Includes all ASME Section XI Appendix VIII specimens & most of the custom designed specimens.
- Designed to customer specifications for their training & qualification of NDT personnel, equipment, and procedures.
- Size of specimens range from a small bolt for a space shuttle in the aerospace industry to a 20,000 pound reactor nozzle in the nuclear industry.
- Detailed documentation is included with specimens. Contact FlawTech for exact details.
- Custom specimens are available at this level of tolerance.

FLAWTECH DISCONTINUITIES LIST

#	FLAW TYPE	WELD	NDT METHOD			
10	TOE CRACK	SV/DV	-	MT/PT	UT	RT
11	TOE CRACK	FILLET	-	MT/PT	UT	-
12	ROOT CRACK	SV	-	MT/PT	UT	RT
13	UNDERBEAD CRACK	FILLET	-	-	UT	-
14	CENTERLINE CRACK (SURFACE)	SV/DV	-	MT/PT	UT	RT
15	CENTERLINE CRACK (SUB SURFACE)	SV/DV	-	-	UT	RT
16	CIRCUMFERENTIAL CRACK (FLUSH CROWN)	SV/DV	-	MT/PT	UT	RT
17	TRANSVERSE CRACK (FLUSH CROWN)	SV/DV	-	MT/PT	UT	-
18	BASE METAL CRACK (CROWN HAZ AREA)	SV/DV	-	MT/PT	UT	-
19	BASE METAL CRACK (ROOT HAZ AREA)	SV	-	MT/PT	UT	-
20	CRATER CRACK (CROWN STOP/START AREA)	SV/DV	VT	MT/PT	-	-
30	POROSITY (SUB-SURFACE)	SV/DV	-	-	UT	RT
31	POROSITY (SUB-SURFACE)	FILLET	-	-	UT	RT
32	POROSITY (SURFACE)	SV /DV	VT	MT/PT	-	-
33	POROSITY (SURFACE)	FILLET	VT	MT/PT	-	-
34	SINGLE GAS PORE	SV/DV	-	-	UT	RT
35	SINGLE GAS PORE	FILLET	-	-	-	RT
36	SLAG INCLUSION (ROOT AREA)	SV	-	-	UT	RT
37	SLAG INCLUSION (WELD GROOVE AREA)	SV/DV	-	-	UT	RT
38	SLAG INCLUSION (ROOT AREA)	FILLET	-	-	UT	RT
39	TUNGSTEN INCLUSION (ROOT AREA)	SV/DV	-	-	-	RT
50	LAMINATION (PREP BASE METAL ONLY)	SV	-	-	UT	-
51	LAMINATION (BASE METAL)	WP FACE	-	MT/PT	-	-
52	LACK OF FUSION (SUB-SURFACE)	SV/DV	-	-	UT	-
53	LACK OF FUSION (SURFACE BREAKING)	SV/DV	-	MT/PT	UT	-
54	LACK OF FUSION (SURFACE BREAKING)	FILLET	-	MT/PT	-	-
55	LACK OF FUSION (ROOT AREA)	SV	-	MT/PT	UT	-
56	INCOMPLETE ROOT PENETRATION	SV	VT	MT/PT	UT	RT
57	INCOMPLETE ROOT PENETRATION	DV	-	-	UT	RT
58	INCOMPLETE ROOT PENETRATION (BRIDGING)	FILLET	-	-	UT	-
59	INCOMPLETE GROOVE WELD (CROWN AREA)	SV/DV	VT	MT/PT	UT	RT
70	ROOT CONCAVITY	SV	VT	-	-	RT
71	EXCESS ROOT PENETRATION	SV	VT	-	-	RT
72	MISALIGNMENT (ROOT & CROWN AREA)	SV	VT	-	-	RT
73	UNEVEN LEG LENGTH	FILLET	VT	-	-	-
74	EXCESS CROWN	SV/DV	VT	-	-	-
75	EXCESS CROWN	FILLET	VT	-	-	-
76	CONCAVE CROWN	SV/DV	VT	-	-	-
77	CONCAVE CROWN	FILLET	VT	-	-	-
78	UNDERCUT	SV/DV	VT	-	-	-
79	UNDERCUT	FILLET	VT	-	-	-
80	OVERLAP	FILLET	VT	MT/PT	-	-
90	WELD SPLATTER	SV/DV	VT	-	-	RT
91	WELD SPLATTER	FILLET	VT	-	-	RT
92	CHIPPING HAMMER MARKS	SV/DV	VT	-	-	RT
93	CHIPPING HAMMER MARKS	FILLET	VT	-	-	-
100	CORROSION	SV/DV	VT	-	UT	RT
101	ERROSION	FILLET	VT	-	UT	RT

FLAWED CROSS SECTION VIEWS



10
Toe Crack in Single Vee
MT/PT, UT

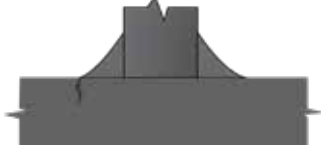

11
Toe Crack in Fillet
MT/PT, UT



12
Root Crack in Single Vee
MT/PT, UT, RT



14
Centerline Crack, Single Vee
(surface breaking) MT/PT, UT, RT



15
Centerline Crack, Single Vee
(sub-surface) UT, RT



15
Centerline Crack in Single Vee
(sub-surface) UT, RT



16
Circumferential Crack in Single
Vee, flush crown MT/PT, UT



17
Transverse Crack in Single
Vee, flush crown MT/PT, UT



18
Base Metal Crack in Single
Vee (top HAZ area)
MT/PT, UT



19
Base Metal Crack in
Single Vee (bottom HAZ area)
MT/PT, UT



20
Crater Crack (crown
stop-start area) MT/PT, UT



30
Porosity in Single Vee
(sub-surface) UT, RT



30
Porosity in Double Vee
(sub-surface) UT, RT



31
Porosity in Fillet
(sub-surface) UT, RT



32
Porosity in Single Vee (surface
breaking) VT, MT/PT

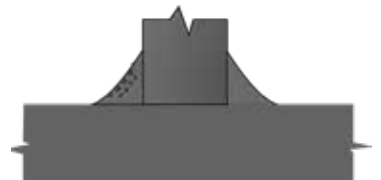

33
Porosity in Fillet
(surface breaking) VT, MT/PT



34
Single Gas Pore in Single
Vee UT, RT



36
Slag Inclusion in Single
Vee (root area) UT, RT



37
Slag Inclusion in Single Vee
(weld groove area) UT, RT



38
Slag Inclusion in Fillet
(root area) UT, RT



39
Porosity in Fillet
(sub-surface) UT, RT



50
Lamination in Single Vee
(base metal) UT



51
Lamination in Weld Prep
MT/PT, UT



52
Lack of Fusion in Single
Vee (crown area) UT



53 Lack of Fusion in Single Vee (surface breaking at crown) MT/PT, UT

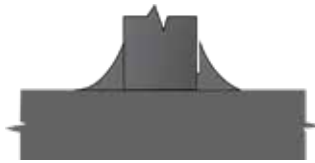

54 Lack of Fusion in Fillet (surface breaking at crown) MT/PT



55 Lack of Fusion in Single Vee (surface breaking at root) MT/PT, UT



56 Incomplete Root Penetration in Single Vee, VT, UT, RT



57 Incomplete Root Penetration in Double Vee, UT, RT



59 Incomplete Groove Weld (crown area) VT, MT/PT, UT, RT



70 Root Concavity in Single Vee VT, RT



71 Excess Root Penetration in Single Vee VT, RT



72 Misalignment, Root & Crown in Single Vee VT, RT



73 Uneven Leg Length in Fillet, VT



74 Excess Crown in Single Vee, VT



75 Excess Crown in Fillet, VT



76 Concave Crown in Single Vee, VT



77 Concave Crown in Fillet, VT



78 Undercut in Single Vee, VT

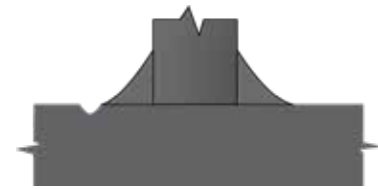

79 Undercut in Fillet, VT



80 Overlap in Fillet VT, MT/PT



90 Weld Splatter on Single Vee, VT, RT



91 Weld Splatter on Filler VT, RT



92 Chipping Hammer Marks on Single Vee, VT, RT



100 Corrosion



101 Erosion



102 Pitted



103 J-Hook

STANDARD KITS

FlawTech Standard Kit Specimens are designed to enhance the training and development of new and veteran technicians. Kits will assist with basic flaw detection and sizing of real flaws found in common weld geometries. Each kit is shown in further detail on the following pages.

RT Kit
#RK-1

UT Kit
#UK-1

MT/PT Kit
#MK-1

VT Kit
#VK-1

EACH KIT CONTAINS:

- 10 Carbon Steel Specimens per kit / custom alloys available
- 20 "Real" flaws per kit / 2 per specimen randomly placed
- "Free" Carrying Case
- Detailed Document Package with CAD drawings

REFERENCE RADIOGRAPHS

#RR-1

- Total of 16 Radiographs
- Showing 20 Real Flaws
- Plus 6 Processing Defects
- Includes Documentation and Film

See the following pages for Kit details.



#RK-1 STANDARD RADIOGRAPHIC TESTING KIT

THE RADIOGRAPHIC KIT CONTAINS:

8 Plates, 1 Pipe & 1 Tee / Carbon Steel

Each specimen contains 2 "REAL FLAWS," randomly placed.

Kit Specifications: 10 specimens

(5) Plates: 0.375" T x 4" x 8"

(3) Plates: 0.625" T x 4" x 8"

(1) Tee: 0.375" T x 4" x 8" x 4"

(1) Pipe: 4" Sch80 (0.337" wall)

Actual X-Ray film is provided for each specimen. Specimens are packaged in 2 FREE CARRYING CASES. Complete with Document Package with "Flaw Truth" documented by CAD drawings with a Standard Tolerance of (+ / -) 0.150" (4mm), CAD Drawings, RT Film and Test Sheets.



The Standard Radiographic Examination Kit contains 20 flaws similar to those shown in the cross section drawings below.

Visit www.flawtech.com or call for price information.

Flaws Included:

- 12 - Root Crack in SV
- 14 - Centerline Crack SV (Surface breaking)
- 15 - Centerline Crack, SV (Sub-surface)
- 30 - Porosity SV / DV
- 31 - Porosity Fillet (sub surface)
- 34 - Single Gas Pore SV
- 36 - Slag Inclusion SV (root area)
- 37 - Slag Inclusion SV (weld groove area)
- 38 - Slag Inclusion Fillet (root area)
- 39 - Tungsten Inclusion SV (root area)
- 56 - Incomplete Root Penetration SV
- 57 - Incomplete Root Penetration DV
- 59 - Incomplete Groove Weld (crown area)
- 70 - Root Concavity SV
- 71 - Excess Root Penetration SV
- 72 - Misalignment Root & Crown SV
- 90 - Weld Splatter SV
- 92 - Chipping Hammer Marks SV

See Pages 3-5 for Cross Section Views

Shipping Weight 65 lbs

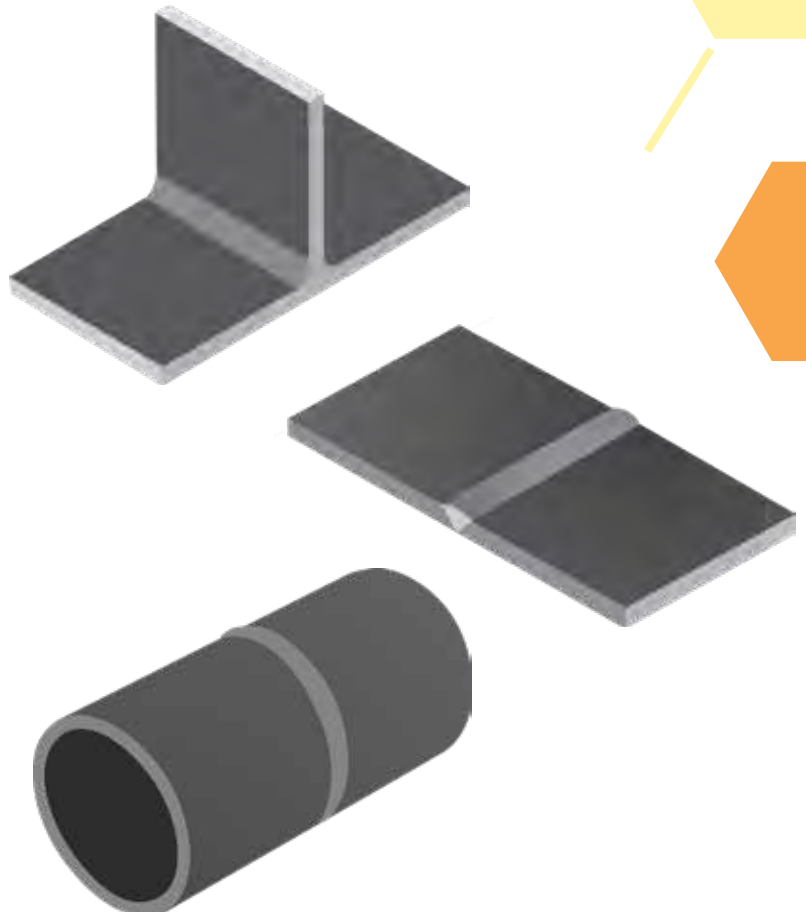

#MK-1

STANDARD MAGNETIC PARTICLE/ LIQUID PENETRANT KIT

THE MT/PT KIT CONTAINS:
8 plates & 2 Tees / Carbon Steel

Each specimen contains 2 "REAL FLAWS,"
randomly placed.

Kit Specifications: 10 specimens
(8) Plates: 0.25"T x 4" x 8"
(2) Tee: 0.25"T x 4" x 8" x 4"

Specimens are packaged in a FREE CARRYING CASE (6" x 16" x 20"). Complete with Document Package with "Flaw Truth" documented by CAD drawings with a Standard Tolerance of (+ / -) 0.150" (4mm), Certificate of Conformance, and Test Sheets.

The Standard MT/PT Kit contains 20 "real" flaws similar to those shown in the cross section drawings below.

Optional PT Kit with STAINLESS SPECIMENS



Flaws Included:

- 10 - Toe Crack SV
- 11 - Toe Crack Fillet
- 12 - Root Crack in SV
- 14 - Centerline Crack SV (surface breaking)
- 16 - Circumferential Crack SV (flush crown)
- 17 - Transverse Crack in SV (flush crown)
- 18 - Base Metal Crack SV (top HAZ area)
- 19 - Base Metal Crack SV (bottom HAZ area)
- 20 - Crater Crack SV (surface stop-start area)
- 32 - Porosity SV (surface breaking)
- 33 - Porosity fillet (surface breaking)
- 51 - Lamination Weld Prep
- 53 - Lack of Fusion SV (surface breaking at crown)
- 54 - Lack of Fusion SV (surface breaking at root)
- 55 - Lack of Fusion SV (surface breaking at root)
- 80 - Overlap Fillet

See Pages 3-5 for Cross Section Views

Shipping Weight 35 lbs

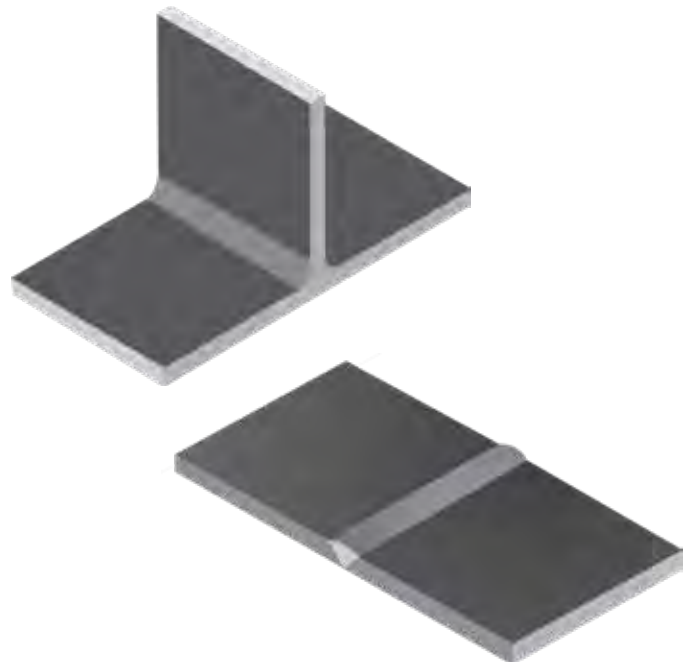

#UK-1 STANDARD ULTRASONIC TESTING KIT

THE ULTRASONIC KIT CONTAINS:

8 Plates, 1 Pipe & 1 Tee / Carbon Steel

Each specimen contains 2 "REAL FLAWS," randomly placed.

Kit Specifications: 10 Specimens

- (4) Plates: 0.375"T x 4" x 8"
- (4) Plates: 0.625"T x 4" x 8"
- (1) Tee: 0.375"T x 4" x 8" x 4"
- (1) Pipe: 4"Sch80 (0.337"T wall)

Specimens are packaged in 2 FREE CARRYING CASES (6" x 16" x 20" each). Complete with Document Package with "Flaw Truth" documented by CAD drawings with a Standard Tolerance of (+ / -) 0.150" (4mm), Certificate of Conformance & Test Sheets.



Flaws Included:

- 10 - Toe Crack SV
- 12 - Root Crack in SV
- 15 - Centerline Crack, SV (Sub-surface)
- 16 - Circumferential Crack SV (flush crown)
- 17 - Transverse Crack in SV (flush crown)
- 18 - Base Metal Crack SV (top HAZ area)
- 30 - Porosity DV (sub-surface)
- 31 - Porosity Fillet (sub-surface)
- 34 - Single Gas Pore SV
- 37 - Slag Inclusion SV (weld groove area)
- 38 - Slag Inclusion Fillet (root area)
- 50 - Lamination SV (base metal)
- 52 - Lack of Fusion SV (crown area)
- 55 - Lack of Fusion SV (surface breaking at root)
- 56 - Incomplete Root Penetration SV
- 57 - Incomplete Root Penetration DV
- 59 - Incomplete Groove Weld (crown area)

See Pages 3-5 for Cross Section Views

Shipping Weight 65 lbs

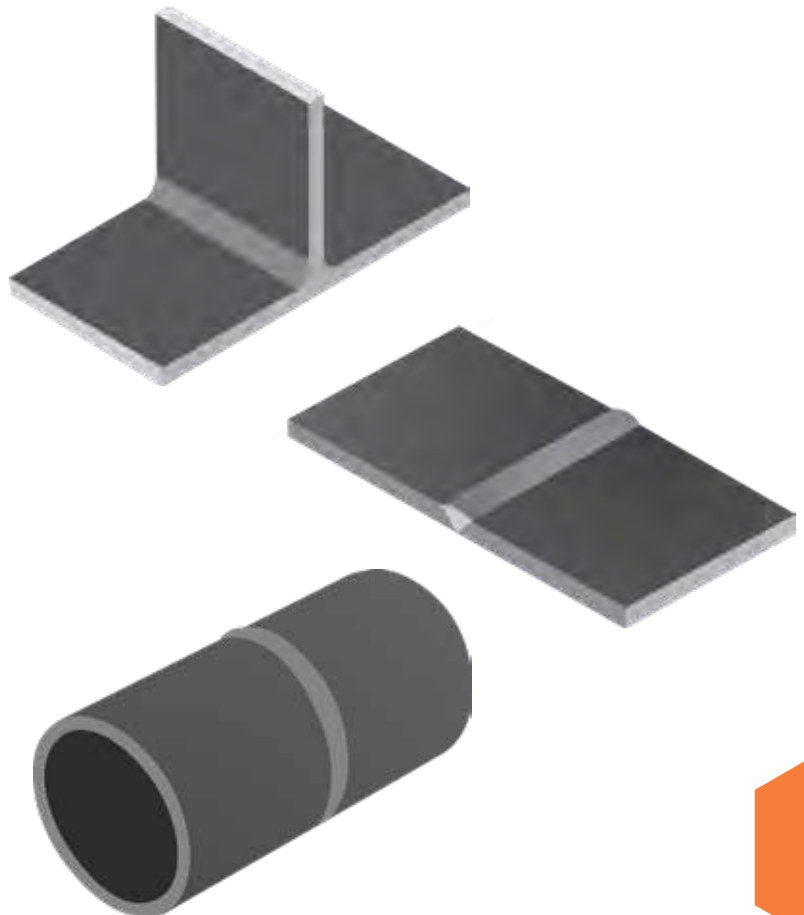

#DK-1 STANDARD NDT DEMONSTRATION KIT

THE NDT DEMONSTRATION KIT CONTAINS:

5 Specimens: 3 Plates, 1 Pipe & 1 Tee
11 Total Discontinuities, "REAL FLAWS," randomly placed

Material: Carbon Steel

Kit Specifications: 5 Specimens

MT/PT (1) Tee: 0.25" T x 4" x 8" x 4"

VT (1) Plate: 0.25" T x 4" x 8"

UT (1) Plate: 0.625" T x 4" x 8"

RT (1) Pipe: 4" Sch80 (0.337" wall) x 8"
& (1) Plate: 0.625" T x 4" x 8"

Flaws: 2 each in plates and tee, 3 in pipe,
for total of 11

Specimens are packaged in a FREE CARRYING CASE (6" x 16" x 20"). The "Flaw Truth" is documented on CAD drawings with a Standard Tolerance of (+ / -) 0.150" (4mm).

This Kit contains actual X-Ray film for RT specimens and a "Flaw Locator" for UT specimens and Certificate of Conformance.



Flaws Included:

- 11 - Toe Crack fillet
- 15 - Center Line Crack DV (sub-surface)
- 18 - Base Metal Crack SV
- 19 - Base Metal Crack in root HAZ
- 20 - Crater Crack (crown stop-start area)
- 30 - Porosity SV (sub-surface)
- 32 - Porosity SV (surface)
- 37 - Slag Inclusion SV
- 54 - Lack of Fusion Fillet (surface breaking)
- 57 - Incomplete Root Penetration DV

See Pages 3-5 for Cross Section Views

Shipping Weight 36 lbs

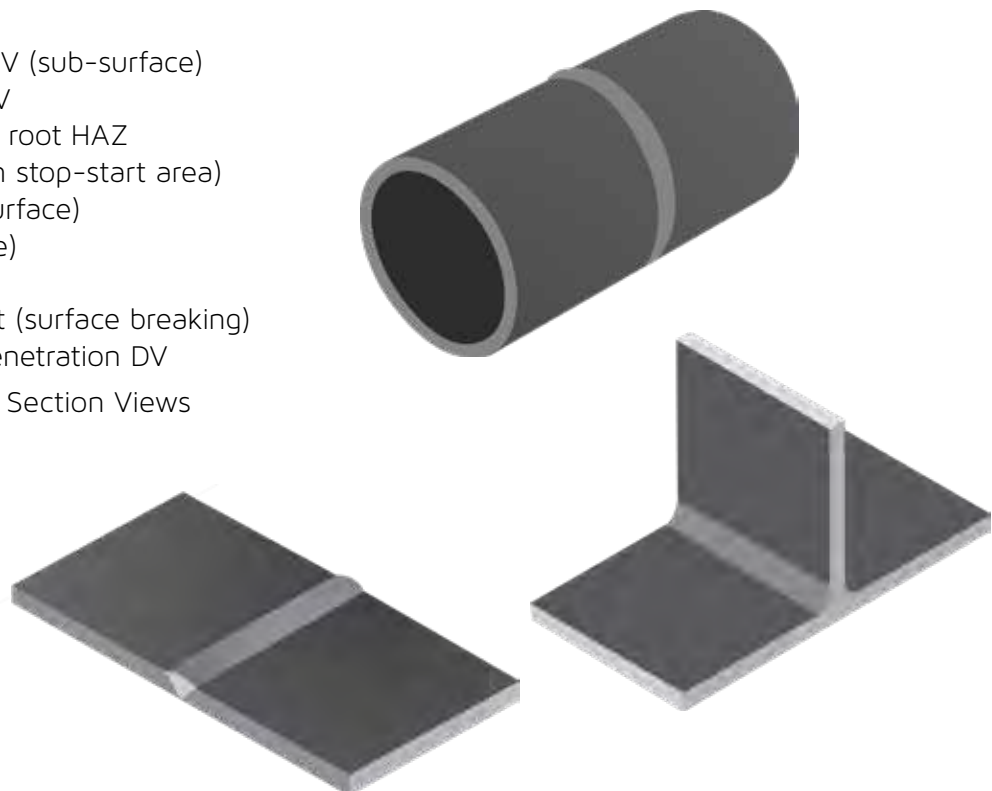

#VK-1

STANDARD VISUAL KIT

THE VISUAL KIT CONTAINS:
7 Plates & 3 Tees / Carbon Steel

Each specimen contains 2 "REAL FLAWS," randomly placed.

Kit Specifications: 10 Specimens
(7) Plates: 0.25" T x 4" x 8"
(3) Tee: 0.25" T x 4" x 8" x 4"
Flaws: 2 each specimen, for total of 20

Specimens are packaged in a FREE CARRYING CASE (6" x 16" x 20"). Complete with Document Package with "Flaw Truth" documented by CAD drawings with a Standard Tolerance of (+ / -) 0.150" (4mm), Certificate of Conformance & Test Sheets.

The Standard Visual Examination Kit contains 20 flaws similar to those shown in the cross section drawings below.



Flaws Included:

- 20 - Crater Crack SV (surface stop-start area)
- 32 - Porosity SV (surface breaking)
- 33 - Porosity fillet (surface breaking)
- 56 - Incomplete Root Penetration SV
- 59 - Incomplete Groove Weld (crown area)
- 70 - Root Concavity SV
- 71 - Excess Root Penetration SV
- 72 - Misalignment Root & Crown SV
- 73 - Uneven Leg Length Fillet
- 74 - Excess Crown SV
- 75 - Excess Crown Fillet
- 76 - Concave Crown SV
- 77 - Concave Crown Fillet
- 78 - Undercut SV
- 79 - Undercut Fillet
- 80 - Overlap Fillet
- 90 - Weld Splatter SV
- 91 - Weld Splatter on Filler

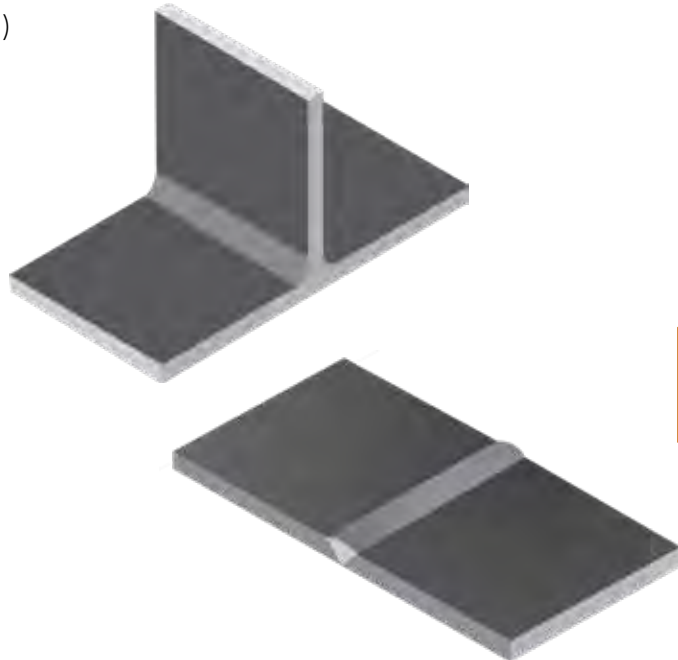

See Pages 3-5 for Cross Section Views

Shipping Weight 65 lbs

(NEW!) MULTI METHOD NDT

#MMNDT-K1

The Ultimate NDT Training and Testing Flawed Specimen Kit

The Kit assists in the training and testing of at least 6 different NDT methods;
UT, RT, MT, PT, VT & ET

Kit contains 30 flaws which cover a wide range of pre-service and in-service flaws types.
Great for comparing indication responses of the different NDT methods.

- (1) Tee, 0.375" T x 4" X 8" x 4" w/ Double Bevel Weld
- (1) Tee, 0.375" T x 4" x 8" x 4" w/ Single Bevel Weld w/ Backing Bar
- (1) Tee, 0.5" T x 4" x 8" x 4" w/ Double Fillet Weld
- (2) Plates, 0.625" T x 4" x 8" w/ Single V Weld Bevel
- (1) Plate, 0.625" T x 4" x 8" w/ Double V Weld Bevel
- (1) Plate, 0.375" T x 4" x 8" w/ Single V Weld Bevel
- (1) Plate, 0.375" T x 4" x 8" w/ Single V Weld Bevel w/ Backing Bar
- (1) Plate, 0.5" T x 4" x 8" w/ Single V Weld Bevel
- (1) Pipe, 4" Sch160 (0.5" wall) x 8" w/ Single V Weld Bevel

KIT SPECIFICATIONS:

- Set of 10 Specimens
- Specimen Alloy Mild
- Carbon Steel
- Custom Alloys Available
- Each Specimen will contain 3 flaws

- Total of 30 flaws

- Each specimen contains flaws that are designed to be detectable using multiple NDT methods.

- Flaws are detectable by a variety of NDT methods:VT, MT, PT, UT (Conventional & PAUT), RT, and ET. Please note that not all flaws are detectable with every method.



KIT DOCUMENTATION INCLUDES:

- Certificate of Conformance
- As Built CAD Drawings
- UT Inspection Reports
- RT, Digital & Film Radiograph Film and Technician Sheet
- Measuring & Test Equipment Certificates
- Test Sheets (used during technician training and testing)
- Kit Includes 2 Carrying Case(s)

CAST SAMPLE KIT

#CA-K1

KIT SPECIFICATIONS:

Qty: 1 Set of 8 Specimens

SPECIFICATIONS:

Each Cast Specimen Set will contain a mix of 8 aluminum cast specimens. There will be limited specimen geometry duplication. The specimens are nominal in size and can be held easily in one hand.

Each specimen will contain a variety of visual casting defects and abnormalities. There is not a standard number of casting defects per specimen. Each specimen is a unique casting and cannot be duplicated.

FlawTech will call out the obvious indications. The skilled inspector may observe indications not documented by FlawTech.

CAST SPECIMEN SETS DOCUMENTATION:

Includes a photograph of each of the 8 specimens' major surface or side. Each photograph will include one or more call outs indicating the location of the prominent defect(s). Each specimen major side will be hard stamped 1A, 1B, 2A, 2B, thru 8A, 8B.

CARRYING CASE DIMENSIONS & KIT WEIGHT:

15" x 13" x 10", ~15LBS

ADD-ON OPTION:

(RT Film and Technique Sheet can be added to the documentation)

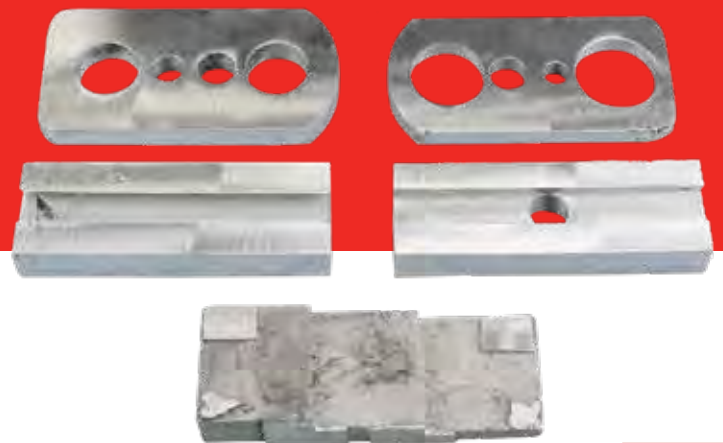

PRACTICAL EXAM SPECIMENS

For UT, MT/PT, and VT

DESIGN SPECIFICATIONS

- Practical exam specimens are larger than our “standard” kit specimens
- 12 UT and 12 MT / PT specimens to choose from
- Each specimen will contain 3 randomly placed “real” flaws
- Designed to enhance the training and qualification of level I & II personnel with regards to ISO9712, PCN & SNT TC-1A
- Customize your set to meet your requirements
- Purchase any combination of specimens to make your set
- Custom specimens are available

See the following pages for Kit details.



ULTRASONIC PRACTICAL EXAM SPECIMENS

PLATES & SHEETS
0.75" x 8" x 10" plate
#P101



BAR & ROD STOCK
1.5" OD x 12"
#P102



BAR & ROD STOCK
4" OD x 6"
#P103



L/R 90° ELBOW TO PIPE
2" SCH160 (.344" T)
#P104



NODE TO PLATE WELD
2" SCH160 to .375" PLATE
#P105



PIPE TO SOCKET WELD
2" SCH160 PIPE to COUPLING
#P106



WELDED PLATE
0.5"x8"x12"
#P107



WELDED PLATE
1.0"x6"x10"
#P108



WELDED PIPING
4" SCH160(0.53"T)x 8"
#P109



LAP JOINT
0.5" x 12" x 6"
#P110



FORGED PIPE FLANGE 6" OD x
0.75" thick
#P111



WELDED TEE
0.5" x 8" x 8" x 4"
#P112



MT / PT & VT PRACTICAL EXAM SPECIMENS

CAST FITTING
2.0" to 1.3" reducer, 5" long
MT/PT #P001
VT #P201



MACHINED SPINDLE
1.75" diameter x 8"
MT/PT #P002
VT #P202

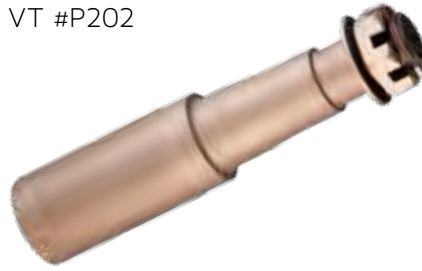

BOLT & NUT
1.25" OD x 6"
MT/PT #P003
VT #P203



FORGED EYE HOOK
6" long with 2" eye
MT/PT #P004
VT #P204



FORGED SHACKLE & PIN
4.25" with 0.75" pin
MT/PT #P005
VT #P205



FORMED METAL PLATE
0.25" x 4"
MT/PT #P006
VT #P206



WELDED PLATE
0.25"x8"x12"
MT/PT #P007
VT #P207



WELDED PIPING
4" SCH40(0.25"T)x 8"
MT/PT #P008
VT #P208



FORGED PIPE FLANGE
6" OD x 0.75" thick
MT/PT #P009
VT #P209



MACHINED GEAR
4.6" diameter x 1.5" bore
MT/PT #P010
VT #P210



WELDED TEE
0.25" x 8" x 8" x 4"
MT/PT #P011
VT #P211



PIPE to SOCKET WELD 2"
SCH160 PIPE to COUPLING
MT/PT #P012
VT #P212



PRACTICAL EXAM SPECIMEN DETAILS: • Standard tolerance (+/-) 0.150" (4mm) • Custom specimens available
• Applicable for ISO9712, PCN & SNT TC-1A • "REAL FLAWS" in each specimen • 3 Flaws per specimen
• Free carrying case with Purchase of 3+ specimens • Specimens are carbon steel
• Blank specimens available • Document Package with each specimen

ADVANCED SPECIMENS

ADVANCED SPECIMENS ARE DESIGNED FOR:

- Training and qualification of level I & II personnel with regards to SNT-TC-1A, ISO 9712 & PCN
- Flaw detection, sizing, & interpretation using common weld geometries and flaw types

ADVANCED SPECIMEN DETAILS:

- Larger than our practical exam specimens
- Complete Document Package Included
- 3 Real Flaws per specimen randomly placed
- Material carbon steel (custom alloys available)
- Custom specimens available (contact us for details)

	PART NUMBER	SPECIMEN TYPE	DIMENSIONS (INCHES)
UT (DESIGNED FOR SHEAR WAVE)	UA-101	Plate w/ SV	0.25" X 12" X 12"
	UA-102	Plate w/ SV	0.375" X 12" X 12"
	UA-103	Plate w/ SV	0.5" X 12" X 12"
	UA-104	Plate w/ SV	0.625" X 12" X 12"
	UA-105	Plate w/ SV	0.75" X 12" X 12"
	UA-106	Plate w/ SV	1.0" X 12" X 12"
	UA-108	Plate w/ SV	1.5" X 12" X 18"
	UA-153	Plate w/ DV	0.5" X 12" X 12"
	UA-155	Plate w/ DV	0.75" X 12" X 12"
	UA-156	Plate w/ DV	1.0" X 12" X 16"
	UA-157	Plate w/ DV	1.25" X 12" X 17"
	UA-158	Plate w/ DV	1.5" X 12" X 18"
	UA-1511	Plate w/ DV	3" X 12" X 18"
	UA-20.753	Pipe w/ SV	0.75" SCHSTD (0.113") X 12"
	UA-20.754	Pipe w/ SV	0.75" SCHXS (0.154") X 12"
	UA-20.755	Pipe w/ SV	0.75" SCH160 (0.219") X 12"
	UA-214	Pipe w/ SV	1" SCHXS (0.179") X 12"
	UA-215	Pipe w/ SV	1" SCH160 (0.25") X 12"
	UA-216	Pipe w/ SV	1" SCHXX (0.382") X 12"
	UA-223	Pipe w/ SV	2" SCHSTD (0.154") X 12"
	UA-224	Pipe w/ SV	2" SCH80 (0.218") X 12"
	UA-226	Pipe w/ SV	2" SCHXX (0.436") X 12"
	UA-22.54	Pipe w/ SV	2.5" SCH80 (0.276") X 12"
	UA-22.56	Pipe w/ SV	2.5" SCHXX (0.552") X 12"
	UA-233	Pipe w/ SV	3" SCH40 (0.216") X 12"
	UA-234	Pipe w/ SV	3" SCH80 (0.3") X 12"
	UA-235	Pipe w/ SV	3" SCH160 (0.438") X 12"
	UA-236	Pipe w/ SV	3" SCHXX (0.6") X 12"
UA-246	Pipe w/ SV	4" SCH80 (0.337") X 12"	
UA-248	Pipe w/ SV	4" SCH160 (0.513") X 12"	
UA-249	Pipe w/ SV	4" SCHXX (0.674") X 12"	
UA-263	Pipe w/ SV	6" SCH40 (0.28") X 12"	
UA-264	Pipe w/ SV	6" SCHXS (0.432") X 12"	
UA-265	Pipe w/ SV	6" SCH120 (0.562") X 12"	
UA-267	Pipe w/ SV	6" SCH160 (0.719") X 12"	
UA-268	Pipe w/ SV	6" SCHXXH (0.864") X 12"	
UA-285	Pipe w/ SV	8" SCH40 (0.322") X 12"	
UA-287	Pipe w/ SV	8" SCH80 (0.5") X 12"	

ADVANCED SPECIMENS

PART NUMBER	SPECIMEN TYPE	DIMENSIONS (INCHES)
UA-288	Pipe w/ SV	8" SCH100 (0.594") X 12"
UA-2810	Pipe w/ SV	8" SCH140 (0.812") X 12"
UA-2812	Pipe w/ SV	8" SCHSTD (0.906") X 12"
UA-2815	Pipe w/ SV	8" w/ 1.5" wall X 12"
UA-2127	Pipe w/ SV	12" SCHXS (0.5") X 12"
UA-21211	Pipe w/ SV	12" SCH120 (1.0") X 12"
UA-2143	Pipe w/ SV	14" SCH20 (0.312") X 12"
UA-2145	Pipe w/ SV	14" SCH40 (0.438") X 12"
UA-2148	Pipe w/ SV	14" SCH80 (0.75") X 12"
UA-21411	Pipe w/ SV	14" SCH140 (1.25") X 18"
UA-21611	Pipe w/ SV	16" SCH160 (1.594") X 20"
UA-303	Tee w/ SV	0.5" X 8" X 8" X 12"
UA-305	Tee w/ SV	0.75" X 8" X 8" X 12"
UA-306	Tee w/ SV	1.0" X 8" X 8" X 12"
UA-356	Tee w/ DV	1.0" X 8" X 8" X 12"
UA-357	Tee w/ DV	1.25" X 9" X 9" X 12"
UA-358	Tee w/ DV	1.5" X 10" X 10" X 12"
UA 407	Y-Joint (45°)	1.25" X 9" X 9" X 12"
UA-51010-6	Node & Carrier (Flat)	10" SCH120 (0.844") X 10" & 1.0" X 20" X 20"
UA-687-6	Y-Node (45°) & Carrier (Flat)	8" SCH80 (0.5") X 10" & 1.0" X 20" X 20"
UA-746-3	Nozzle & Carrier (Flat)	4" SCHXS (0.377") X 6" & 0.5" X 12" X 12"
UA-748-3	Nozzle & Carrier (Flat)	4" SCH160 (0.531") X 6" & 0.5" X 12" X 12"
UA-787-6	Nozzle & Carrier (Flat)	8" SCH80 (0.5") X 10" & 1.0" X 20" X 20"
UA-787-20C	Nozzle & Carrier (20" OD X 90° Segment)	8" SCH80 (0.5") X 10" & 20" OD X 0.375" wall X 16" X 90°
UA-7127-3	Nozzle & Carrier (Flat)	12" SCHXS (0.5") X 10" & 0.5" X 24" x 24"
UA-7129-3	Nozzle & Carrier (Flat)	12" SCH80 (0.688") X 10" & 0.5" X 24" x 24"
RT RA-102	Plate w/SV	0.375" x 12" x 12"
RT RA-103	Plate w/SV	0.5" x 12" x 12"
RT RA-105	Plate w/SV	0.75" x 12" x 12"
RT RA-106	Plate w/SV	1.0" x 12" x 16"
RT RA-154	Plate w/DV	0.625" x 12" x 12"
RT RA-155	Plate w/DV	0.725" x 12" x 12"
RT RA-156	Plate w/DV	1.0" x 12" x 16"
RT RA-157	Plate w/DV	1.25" x 12" x 17"
RT RA-223	Pipe w/SV	2" SCH40 (0.154") X 12"
RT RA-224	Pipe w/SV	2" SCH80 (0.218") X 12"
RT RA-225	Pipe w/SV	2" SCH160 (0.344") X 12"
RT RA-226	Pipe w/SV	2" SCHXX X (0.436) 12"
RT RA-242	Pipe w/SV	4" SCH10 (0.12") X 12"

RT	RA-243	Pipe w/SV	4" SCH40 (0.237") X 12"
	RA-246	Pipe w/SV	4" SCH80 (0.337") X 12"
	RA-248	Pipe w/SV	4" SCH160 (0.531") X 12"
	RA-266	Pipe w/SV	6" SCH120 (0.562") X 12"
	RA-282	Pipe w/SV	8" SCH10 (0.148") X 12"
	RA-285	Pipe w/SV	8" SCH40 (0.322") X 12"
	RA-288	Pipe w/SV	8" SCH100 (0.594") X 12"
	RA-2810	Pipe w/SV	8" SCH140 (0.812") X 12"
	RA-2126	Pipe w/SV	12" SCH40 (0.406") X 12"
	RA-2127	Pipe w/SV	12" SCHXS (0.5") X 12"
RA-2129	Pipe w/SV	12" SCH80 (0.688") X 12"	

ET	ET-101A	Plate (No Weld w/ 4 Flaws)	0.25" x 4" x 12"
	ET-101B	Plate w/ SV	0.25" x 4" x 12"
	ET-101C	Plate w/ SV (4 Flaws)	0.25" x 4" x 12"
	ET-101D	Plate w/ SV (4 EDM Elliptical Notches)	0.25" x 4" x 12"

MT/PT & VT	PA-102		Plate w/SV (Stainless Steel)	0.375" x 12" x 12"
	MA-102	VA-102	Plate w/SV	0.375" x 12" x 12"
	MA-223		Pipe w/SV	2" SCH40 (0.154") x 12"
	MA-224	VA-224	Pipe w/SV	2" SCH80 (0.218") x 12"
	MA-234		Pipe w/SV	3" SCH80 (0.3") x 12"
	MA-242	VA-242	Pipe w/SV	4" SCH10 (0.120") x 12"
	MA-246	VA-246	Pipe w/SV	4" SCH80 (0.337") x 12"
	MA-265	VA-265	Pipe w/S-V	6" SCH80 (0.432) x 12"
	MA-282	VA-282	Pipe w/SV	8" SCH10 (0.148") x 12"
	MA-285	VA-285	Pipe w/SV	8" SCH40 (0.322") x 12"
	MA-2126	VA-2126	Pipe w/S-V	12" SCH40 (0.406") x 12"
	MA-2127	VA-2127	Pipe w/SV	12" SCHXS (0.5") x 12"
	MA-302	VA-302	Tee w/SV	0.375" x 6" x 6" x 12"
	MA-303	VA-303	Tee w/ SV	0.5" x 6" x 6" x 12"
	MA-402	VA-402	Y-JOINT (45°)	0.375" x 6" x 6" x 12"
	MA-5106-3	VA-5106-3	NODE & CARRIER (Flat)	10 SCH40 (0.365") x 10 & 0.5" x 16" x 16"
	MA-5107-3	VA-5107-3	NODE & CARRIER (Flat)	10 SCH60 (0.5") x 10 & 0.5" x 16" x 16"
	MA-686-3	VA-686-3	Y-NODE (45) & CARRIER (Flat)	8" SCH60 (0.4") x 10" & 0.5" x 16" x 16"
	MA-786-3	VA-786-3	NOZZLE & CARRIER (Flat)	8" SCH60 (0.4") x 10" & 0.5" x 16" x 16"
	MA-787-7	VA-786-7	NOZZLE & CARRIER (Flat)	8" SCH60 (0.4") x 10" & 1" x 16" x 16"

All pipe sizes and plate thicknesses are available.

CORROSION, EROSION, & LAMINATION SPECIMENS

Four Section Plate

Corrosion, Erosion, & Lamination UT Thickness Training & Certification Plates

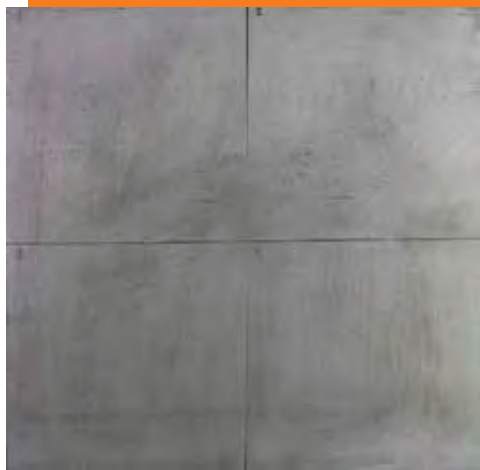

1018 Carbon Steel:

CEL-4C1: 0.25" T
CEL-4C2: 0.375" T
CEL-4C3: 0.50" T
CEL-4C4: 0.625" T
CEL-4C5: 0.75" T
CEL-4C6: 1.0" T

304 Stainless Steel:

CEL-4S1: 0.25" T
CEL-4S2: 0.375" T
CEL-4S3: 0.50" T
CEL-4S4: 0.625" T
CEL-4S5: 0.75" T
CEL-4S6: 1.0" T



SPECIFICATIONS:

- Plates will be divided into 4 sections with machined scribe lines and identified A, B, C, & D on top of the plate.
- The opposing side (host side) of the plate will host 2 randomly placed simulated corrosion, erosion, and/or laminations.
- The host side of the plate will be covered with a "removable" cover plate.
- Plates are 8" x 8"
- Full documentation package included

Sixteen Section Plate

Corrosion, Erosion, & Lamination UT Thickness Training & Certification Plates

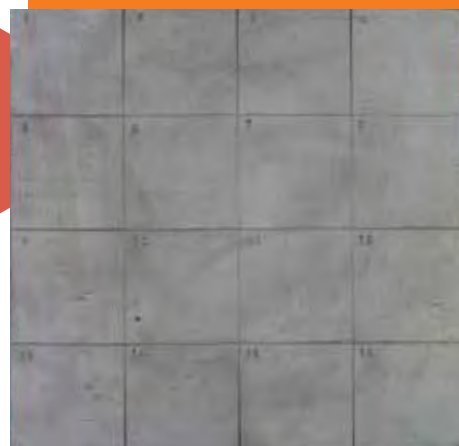

1018 Carbon Steel:

CEL-16C1: 0.25" T
CEL-16C2: 0.375" T
CEL-16C3: 0.50" T
CEL-16C4: 0.625" T
CEL-16C5: 0.75" T
CEL-16C6: 1.0" T

304 Stainless Steel:

CEL-16S1: 0.25" T
CEL-16S2: 0.375" T
CEL-16S3: 0.50" T
CEL-16S4: 0.625" T
CEL-16S5: 0.75" T
CEL-16S6: 1.0" T



SPECIFICATIONS:

- Plates will be divided into 16 sections with machined scribe lines and identified A, B, C, & D on top of the plate.
- The opposing side (host side) of the plate will host 4 randomly placed simulated corrosion, erosion, and/or laminations.
- The host side of the plate will be covered with a "removable" cover plate.
- Plates are 8" X 8"
- Full documentation package included.

(NEW!) FLAWTECH BUBBLE LEAK KIT #BL-K1

SPECIFICATIONS:

Set contains (1) 6" x 12" Vacuum Box with a viewing window of 4" x 10".

- Vacuum Box is designed for flat surfaces.
- Vacuum Box has a 1" thick foam gasket, 30 max (in Hg) vacuum gauge, venturi with muffler and standard ¼ male quick disconnect air fitting.

Kit comes with (3), 12" x 20" x 0.125" T stainless steel plates.

Each plate will contain 4 to 6 flaws for a total of 15 flaws.

- (1) plate will have two 20" welds
- (1) plate will have four ~12" welds
- (1) plate will have no welds
- Kit includes a bottle of bubble leak solution.
- Please note the Kit does not include air hose or air compressor, however these items can be included as an option.
- FlawTech can manufacture custom vacuum boxes for most any geometry.

Flaw types include: Pin Holes, Toe Cracks, HAZ Cracks, Base Metal Cracks, Corrosion w/ Pin Holes

Kit Documentation Includes:

- Certificate of Conformance
- As Built CAD Drawings
- Measuring & Test Equipment Certificates
- Test Sheets (used during technician training and testing)

Kit Includes 1 Carrying Case

Total Weight ~60 LBS



#API-CSB-1

API CRACK SIZING BARS

QUANTITY: SET of 10

Bar Specifications:

- Carbon Steel
- Single V Groove
- Bars will be $3\frac{1}{4}W \times 10\frac{1}{4}L$
- The crowns may be as welded or ground flush—client choice
 - Weld root will be as welded
 - Weld root will be located in the center of the 10" bar
- Each bar will contain a single surface connected "thumbnail", "straight" or "asymmetrical" shaped crack — client choice
 - The crack ID surface length will span the $3\frac{1}{4}$ width of the bar
 - The crack through wall depths: 80%, 70%, 60%, 50%, 45%, 40%, 30%, 20%, 10%, 10% and 5%
 - Depths can be adjusted as needed
 - The asymmetrical-shaped cracks may have 2 specified depths
 - The crack locations will vary from HAZ, Centerline, Toe and Root as requested by client
- Bar sides will be dressed with sharp edges chamfered.
- Flaw Tolerance +/- 0.080
- Documentation: Includes Certificate of Conformance, "As Built" CAD drawings, Measuring & Test Equipment Certificates and Test Sheets

Available in a set of 10 or sold individually:

Part #API-CSB-1, $0.250\frac{1}{4}T$

Part #API-CSB-2, $0.375\frac{1}{4}T$

Part #API-CSB-3, $0.500\frac{1}{4}T$

Part #API-CSB-4, $0.625\frac{1}{4}T$

Part #API-CSB-5, $0.750\frac{1}{4}T$

Part #API-CSB-6, $1.00\frac{1}{4}T$

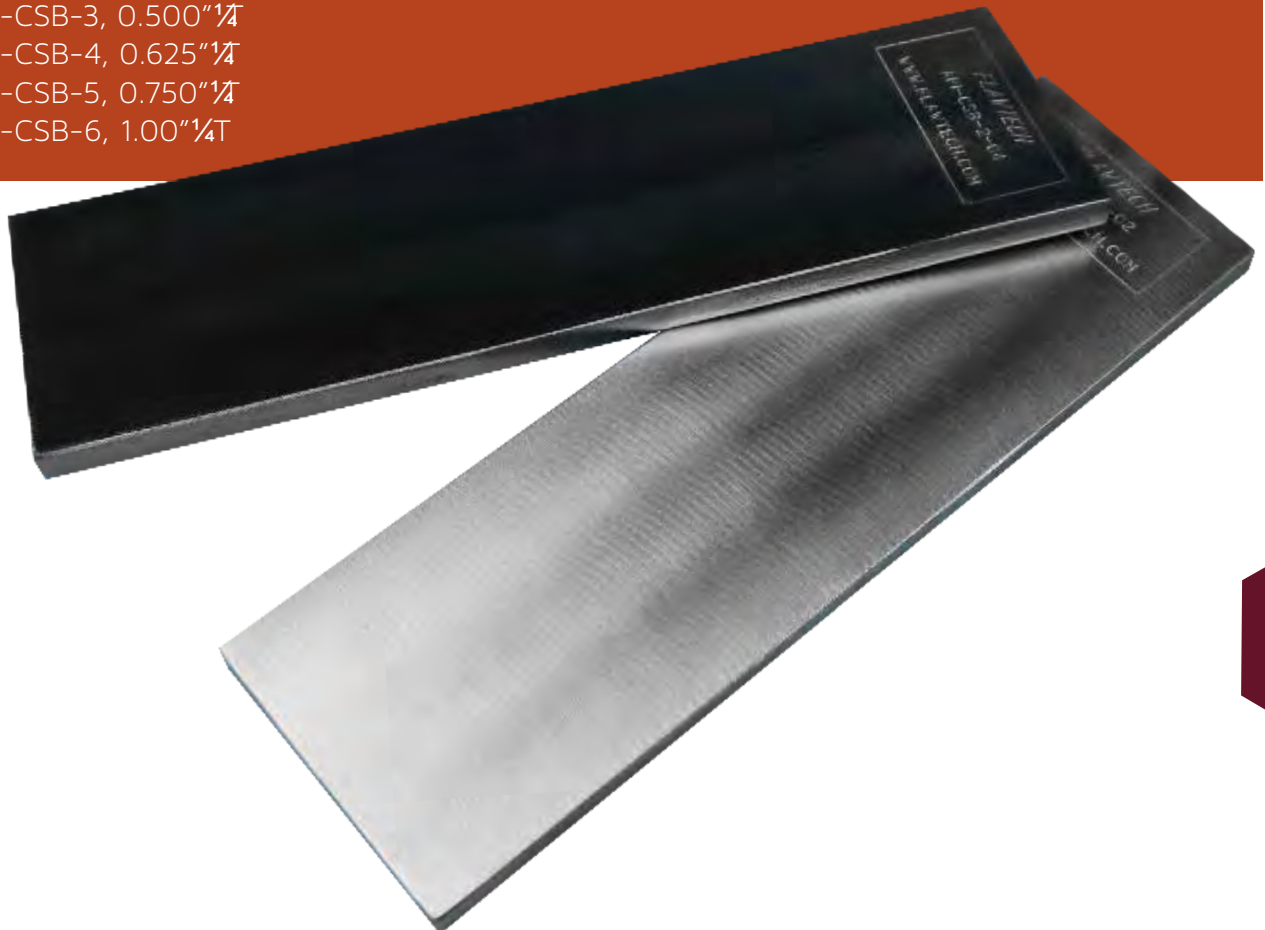

#API-K1 API-UT-1 FLAWED SPECIMEN KIT

For UT Examination of Ferritic Welds

API-UT-1 KIT CONTAINS:

Total Of 4 Specimen

- (1) 1.0" Thick Plate W/ Double Vee (1" X 12" X 15")
- (1) 0.5" Thick Plate W/ Single Vee (0.5" X 10" X 12")
- (1) 8" Sch 80 Pipe (0.5" Wall X 12", 360°)
- (1) 12" Sch 80 Pipe (0.688", Wall X 12", 180° Seg.)

Due to the high demand of this Original FlawTech Kit, FlawTech offers custom flaw design options. Contact FlawTech for more details.

API KIT STANDARD FEATURES

- Complete Document Package W/ CAD Drawings
- Approximately 3 "Real" Flaws Per Specimen
- FlawTech Advanced Tolerance ± 0.080 "
- Specimens Are Carbon Steel

API KIT CUSTOM OPTIONS

- 10% ID / OD Calibration Notches
- 0.75" X 4.5" X 6" ASME Sec. V Basic Calibration Block
- 8" Sch 80 (0.5" Wall) X 8" Pipe Asme Sec. V Angle Beam Calibration Block
- Locking Storage Container
- Radiographs

FLAW TYPES

- Lack Of Penetration
- Center Line Crack
- Slag Inclusion
- Lack Of Fusion
- Root Crack
- Porosity
- Misalignment
- Excess Penetration

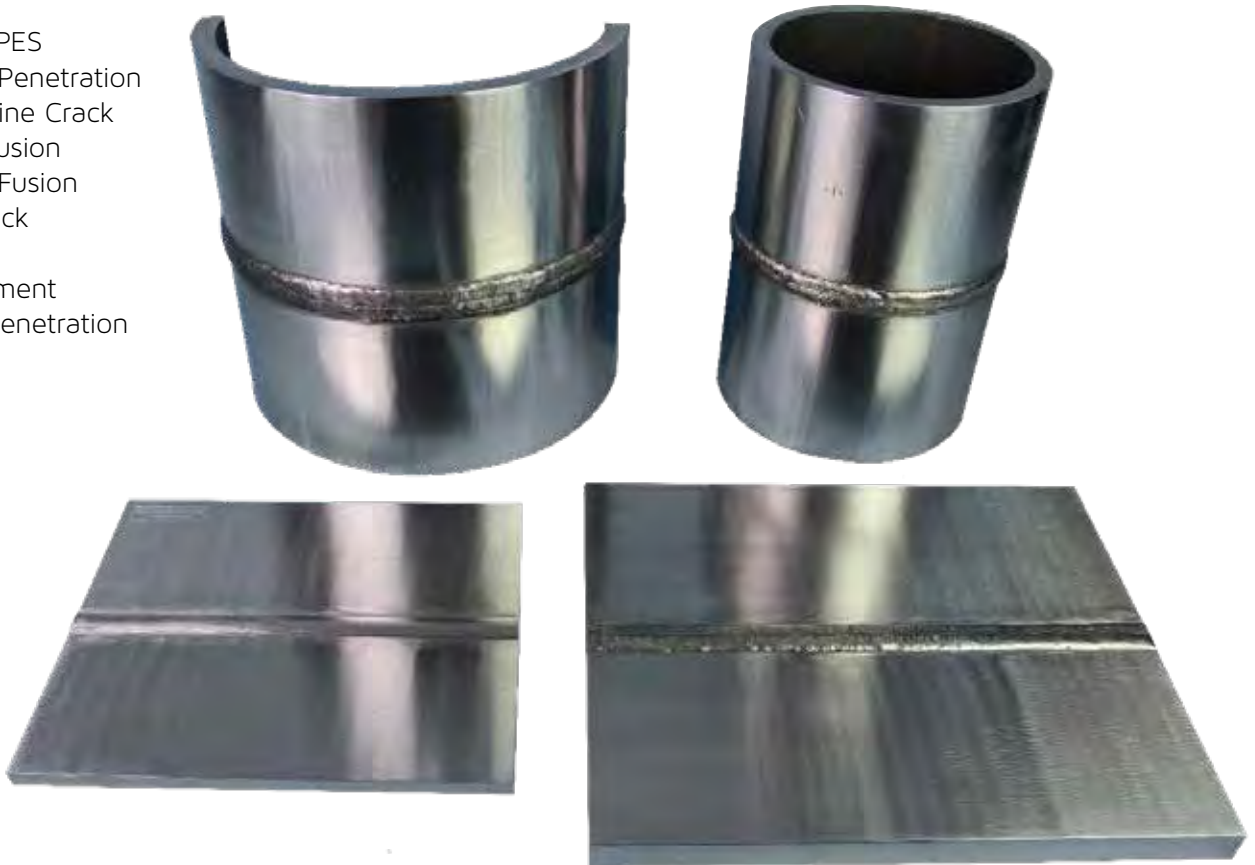

#API-MK

API-UT-MINI KIT

Compact version of our API-UT-1 kit

API-UT-1 MINI KIT CONTAINS:

Total of 4 specimen

- (1) 1.0" Thick Plate w/ Double Vee (1" x 7.5" x 6")
- (1) 0.5" Thick Plate W/ Single Vee (0.5" X 6" X 5")
- (1) 8" Sch 80 Pipe (0.5" Wall X 6", 180°)
- (1) 12" Sch 80 Pipe (0.688", Wall X 6", 90° Seg.)

API MINI KIT STANDARD FEATURES

- Complete document package w/ CAD drawings
- 3 "real" flaws per specimen
- FlawTech advanced tolerance +/- 0.080"
- Specimens are carbon steel
- Designed for ease of handling and transport
- Carrying case 15" x 13" x 10"
- Total weight 50lbs

Note: Specimens may be too small for some UT search units. If this is a concern please consider our standard API-UT-1 Kit.



#RP2X-K1

API RP-2X SPECIMEN KIT

API RP-2X PRACTICE SPECIMEN KIT

Material: 0.75" Carbon Steel Plate
SET OF 3 SPECIMENS

- 90° "T" Connection - 0.75" (T) X 20" (Weld Length) X ~4" X 8" Leg
- 45° Connection - 0.75" (T) X 20" (Weld Length) X 4" X 8" Leg
- 60° Connection - 0.75" (T) X 20" (Weld Length) X 4" X 8" Leg

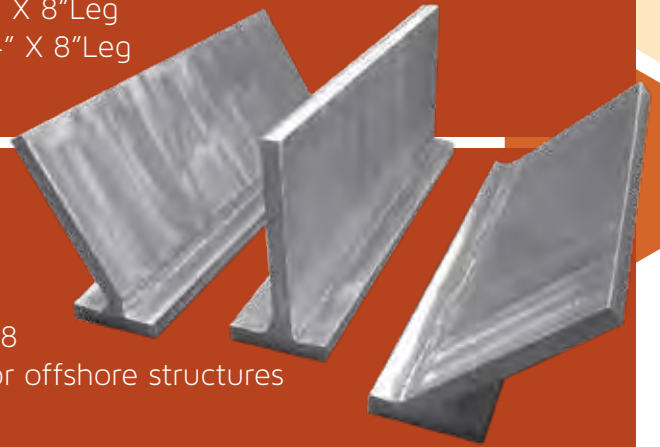

SPECIMEN DETAILS

- Each specimen contains 4 flaws / 12 total
- API Level "C" Criteria used for flaw design
- Flaw accept / reject based on API RP-2X, fig. 45 & 48
- UT specimens can be used for technician practice for offshore structures
- Flaw acceptability is not determined by ultrasonics
- Also available in stainless steel

CUSTOM OPTIONS AVAILABLE

#RP2X-PE API RP-2X PRACTICE TEST KIT

Designed in the spirit of API RP-2X, these specimens offer a technician advanced training in UT flaw detection & sizing in unique configurations. This kit is a great tool for conducting practical examinations, as well as preparing technicians for typical industry exams.

THE AP RP-2X EXAM KIT CONTAINS:

- 0.75" T Tee Specimen w/ Double Vee Weld
- 0.75" T 60° "Y" Specimen
- 1" T Plate Specimen w/ Backing Bar
- 8" Sch 60 Pipe Specimen, 180° Segment
- 10-12 Flaws Total, Including Cracks & Weld Discontinuities

CUSTOM OPTIONS AVAILABLE



FLAWTECH AWS D1.5 UT BRIDGE KIT (NEW!)

#BK-1

SET OF 8 SPECIMENS:

- Specimen Alloy: Mild Carbon Steel
- Each Specimen will contain 3 flaws
- Total of 24 flaws in the Kit.
- Flaws that are designed to be detectable using UT (Conventional & PAUT).
- Flaws are a specially selected to represent fabrication and in-service indications.

Kit Specimen Design and Joint Designations per Figure 2.4 AWS D1.5 Include:

- Specimen #1: #B-U3b, Double Bevel Groove Weld-Butt Joint Plate w/ Flush Crowns, 0.75" T x 12" X 12"
- Specimen #2: #B-U3b (modified), 2/3-1/3 Double Bevel Groove Weld-Butt Joint Plate w/ Flush Crowns, 1.0" T x 14" x 14"
- Specimen #3: #B-U3b, Double Bevel Groove Weld-Butt Joint Thickness Transition w/ Chamfering and Offset Alignment Plate w/ As Welded Crowns, 1.0" to 0.5" T x 12" x 12"
- Specimen #4: #B-U2, Single V Groove Weld-Butt Joint Plate w/ Flush Crown & Root, 0.75" T x 12" x 12"
- Specimen #5: #TC-U5b, Double Bevel Groove Weld -T-Joint (Flange to Web) w/ As Welded Crowns, 0.75" T x 6" Web to 1" T X 4.5" Flange x 12" (weld length)
- Specimen #6: Recommended, Single V Groove – Skewed Joint w/ Back Gouge, 45° Skewed Connection Plate w/ As Welded Crown, 0.5" T x 6" x 6" (weld length) Connection to 0.75" T x 8" x 10" Web
- Specimen #7: #B-U3b, Double Bevel Groove Weld-Butt Joint Thickness Transition w/ Chamfering and Centerline Alignment Plate w/ As Welded Crowns, 1.0" to 0.5" T x 12" x 6" (weld length)
- Specimen #8: #TC-U4c, Single Bevel Groove Weld-Corner Joint Corner w/ Backing Bar & As Welded Crown, 0.75" T x 6" x 6"

KIT DOCUMENTATION INCLUDES:

- Certificate of Conformance
- As Built CAD Drawings
- UT Inspection Reports
- Measuring & Test Equipment Certificates
- Test Sheets (used during technician training and testing)

OPTIONAL FEATURES: (Items not included in the Kit – contact FlawTech for pricing.)

- Recommended Optional Plate (not included in the Kit)
 - Specimen #9: #B-U3b, Double V Groove Weld-Butt Joint Plate. w/ 4 flaws 3.0" T x 30" x 12" (weld length)
- Radiography
 - Digital & Film Radiograph Film and Technique Sheets

Kit Specimens #'s may be purchased individually.

Custom Alloys Available

Shipping Container:
32" x 20" x 21"

Total Weight ~300 LBS

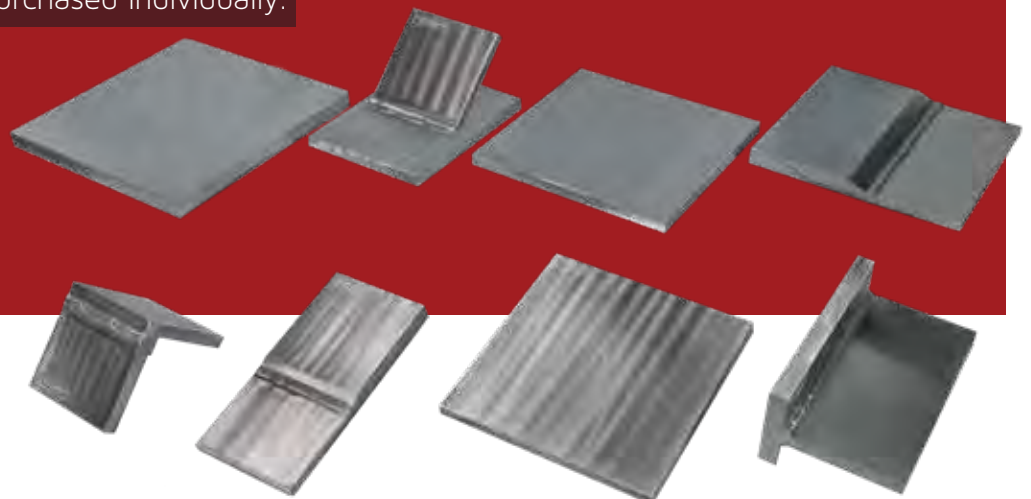

FLAWTECH RT “STACKED” KIT (NEW!)

KIT PURPOSE:

#RTS-K1

The RT Stacked Kit is designed to allow the RT technician to adjust the thickness of a shot from 0.25” up to 2” T. The plate specimen has tick marks in 2” increments along the plate edges. These tick marks allow the technician to quickly adjust the plates axial location which in turn will move the flaw location(s) along the axis of the weld. The Kit design allows the technician to also shuffle the plates from top to bottom, thus providing the technician with thousands of possible plate thicknesses and flaw locations.

KIT CONTAINS 8 PLATE SPECIMENS

- Each specimen is 0.25” T x 4” x 8” Carbon Steel
- Of the 8 plates, 6 contain flaws and 2 are blanks.

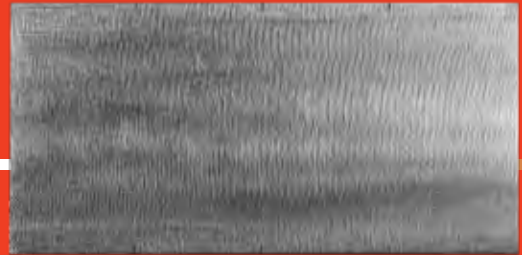

FLAWS INCLUDED:

- (1) IP
- (2) Slag Inclusions
- (1) LOF (sidewall)
- (1) Centerline Crack
- (1) Group Porosity

Each plate has a weld that runs the 8” length of the plate and the crowns and roots have been ground flush in order to accommodate the stacking of the plates.

KIT DOCUMENTATION INCLUDES:

- Certificate of Conformance
- As Built CAD Drawings
- RT Film & Technician Sheet (RT per ASME Sec. V)
- Measuring & Test Equipment Certificates
- Test Sheets (used during technician training and testing)
- Kit Includes 1 Carrying Cases

Total Weight ~35 LBS



AWS / CWI VISUAL SPECIMEN KIT

Design Specifications Based On AWS D1.1

AWS-K1

KIT CONTAINS 10 SPECIMENS

- Flaws Are Randomly Placed
- (4) Tees 4" X 6" X 2" X 0.25"
- (4) Plates 4" X 6" X 0.25"
- (2) Edge & Lap Joints 4" X 6" X 0.3125"

AWS / CWI KIT DESIGN FEATURES

- 2 Flaws Per Specimen
- Flaws Are Randomly Placed
- Flaws Are "Border Line" Acceptable or Rejectable
- Carbon Steel Specimens
- Welding Process - SMAW
- Document Package W/ Cad Drawings
- "Free" Carrying Case
- Designed Specifically For Visual Weld Inspection Training

AWS / CWI KIT FLAWS

- Undercut
- Crater Crack
- Excessive Convexity
- Undersize Leg
- Cluster Porosity
- Arc Strike
- Overlap
- Longitudinal Crack
- Aligned Porosity
- Incomplete Penetration
- Excessive Reinforcement
- Underfill
- Concavity
- Transverse Crack
- Oversize Leg



TRAVELER CWI VISUAL TRAINING KIT

Design Specifications Based On AWS D1.1

#TCWI-K1

FlawTech's new polymer specimen set developed specifically for CWI training and testing. Efficiently designed to provide a maximum number of indications with minimal weight to support the traveling CWI instructor.

Flaws are Intended to be "Borderline" acceptable or rejectable. The end user (CWI) must make that determination.

KIT SPECIFICATIONS:

- 1 Carrying Case 6" X 16" X 20," ~16lbs
- All 15 samples fit into one case
- Light weight for easy transport
- Complete document package includes CAD drawings
- 3 to 4 flaws per specimen for a total of 50 weld flaws per kit
- Specimens also contain various weld bevels and flame cut edges
- (6) Plates
- (3) Tee Joints
- (6) 180° Pipe Segments

(Optional) Weld Size and
CAM Gauges



AWS / CWI PLUS PT ENDORSEMENT KIT

#AWS-K2

Design Specifications Based On AWS

Kit Contains 10 Specimens

- (2) PLATES 4" X 6" X 0.25"
- (1) PIPE 4" SCH80 X 6"
- (1) TEE 4" X 6" X 2" X 0.25"
- (1) SOCKET WELD 2" SCH80 X 6"
- (5) PLATES 1" X 4" X 0.25"

AWS / CWI KIT DESIGN FEATURES:

- 2 + Flaws Per Specimen
- Flaws Are Randomly Placed
- Flaws Are "Border Line" Acceptable Or Rejectable
- Carbon Steel Specimens
- Welding Process - SMAW
- Document Package W/ CAD Drawings
- "Free" Carrying Case
- Designed Specifically For PT Weld Inspection Training

AWS/CWI CERTIFIED KIT

- FlawTech worked in conjunction with AWS and EPRI in the development of this kit.
- This kit has been designed to incorporate both basic penetrant training and testing of the CWI



AWS STRUCTURAL WELD SEISMIC KIT

Based On AWS D1.8 Annex E For Structural Welds

#AWS-SSK

AWS Seismic Supplement for UT Testing

- Based on AWS D1.8 Annex E For Structural Welds
- AWS Seismic Supplement for UT Testing
- Qty: 1 Set of 8 specimens
- Material: A36 or 1018 carbon steel

Material: A36 or 1018 carbon steel

Specifications: Total of 8 Welded Specimens:

2 Butt Welds w/ V Groove (1) at 0.375" T and (1) at 0.75" T X 6" (Weld) X 8"

2 Butt Welds w/ V Groove w/ Backing Bar, (1) at 0.375" T and (1) at 0.75" T X 6" (Weld) X 8¼"

2 Tee Welds w/ Single Groove, (1) at 0.375" T & (1) at 0.75" T X 6" (Weld) X 6" Main X 7" (Branch)

2 Tee Welds w/ Single Groove w/ Backing Bar, (1) at 0.375" T and (1) at 0.75" T X 6" (weld length) X 6" Main X 7" Branch

Flaws: Total of 20 (~2 – 3 per specimen) sub-surface and surface breaking flaws randomly placed throughout the volume of the weld. The flaw sizes will vary from approximately +1" to -0.5" in length and +/- 0.25" in height.

Tolerance: +/- 0.080"

Weld Condition: Surface condition of the crown and root will be "as welded."

Documentation: Certificate of Conformance, "As Built" CAD, RT Inspection Film and Technique Sheet (as per ASME Sec.V, Art.2), UT Inspection Report and Measuring and Test Equipment Certificates

Carrying Case: Included (Rolling & Lockable)

Kit Weight: ~125 lbs

Dimensions: 24" x 16" x 10"



WELD JOINT KITS

Pipe to Fitting & Pipe to Vessel Specimens

SET OF 6 SOCKET WELD SPECIMENS

3 ALLOY OPTIONS

- 304 SS #SOC - K1
- 316 SS #SOC - K2
- 106 CS #SOC - K3

PIPE DIMENSIONS

- 0.75" SCH80
- 1.0" SCH 80
- 2.0" SCH 80

FLAW SPECIFICATIONS

- 2 Flaws Each Specimen
- Total Of 12 Real Flaws
- Fatigue, Haz Cracks, and Lacks of Fusion

2 SPECIMENS PER PIPE SIZE

- (1) Pipe To Socket Coupling
- (1) Pipe To 1.5" X 6" X 6" Plate w/ Machined Socket

PURCHASE OPTIONS

- Kit / Set Contains 6 Specimens
- Individually / Purchase 1 Or More
- Customize Your Set / Mix Different Alloys

Specimens are Designed for Ultrasonic Practice Inspection of Pipe To Fitting and Pipe to Vessel Welds

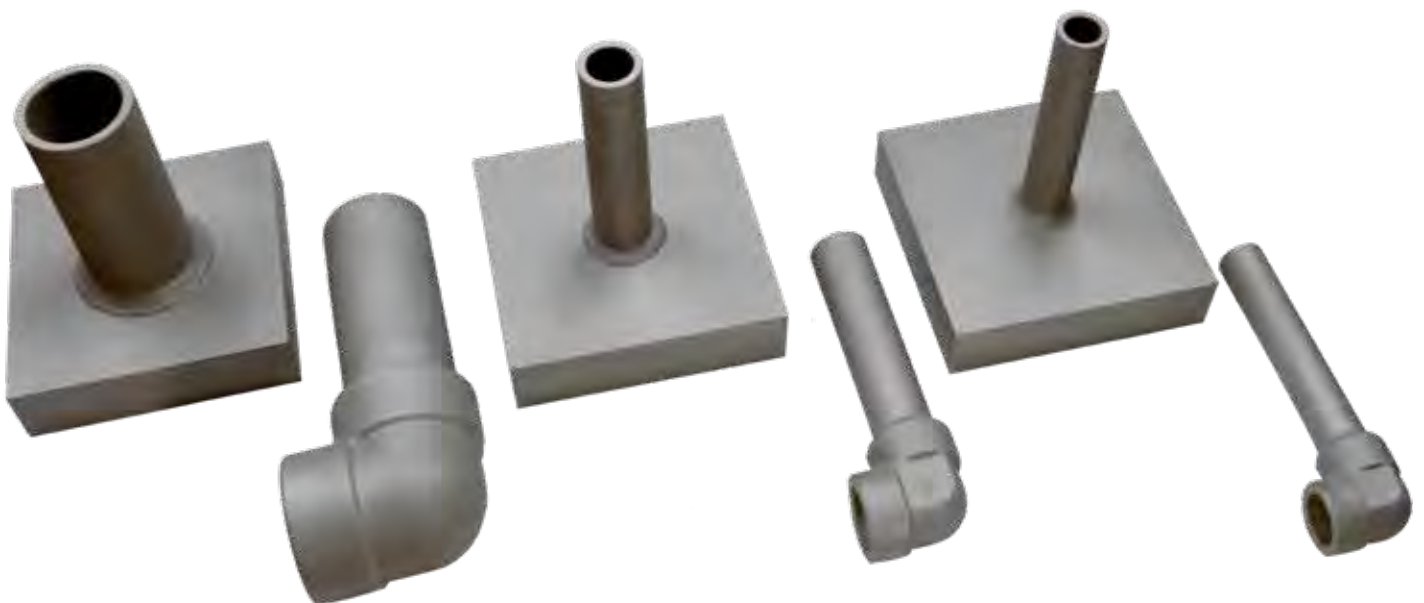

BORESCOPE SAMPLE KIT

#BS-K1

KIT SPECIFICATIONS:

Qty: 1 Set of 8 Specimens

MATERIAL:

304 s/s

NPS 1.5" Sch80 Pipe and
Long Radius 90° Elbow

SPECIFICATIONS:

Each specimen will contain a minimum of two (2) ID connected flaws. Combination of pre-service and post-service indications.

Each specimen will have the elbow end sealed with a 0.625" port to allow borescope access. The pipe end will contain a removable plug for ease of viewing during training and access for larger diameter borescopes.

TOLERANCE: +/-0.150"

WEIGHT: 35lbs

DOCUMENTATION:

Includes C of C, "As Built"
CAD Drawings and
Measuring & Test Equipment
Certificates

Carrying Case included.

This can also be used for VT, UT,
and RT.

Carbon steel specimens are
available

Also available individually

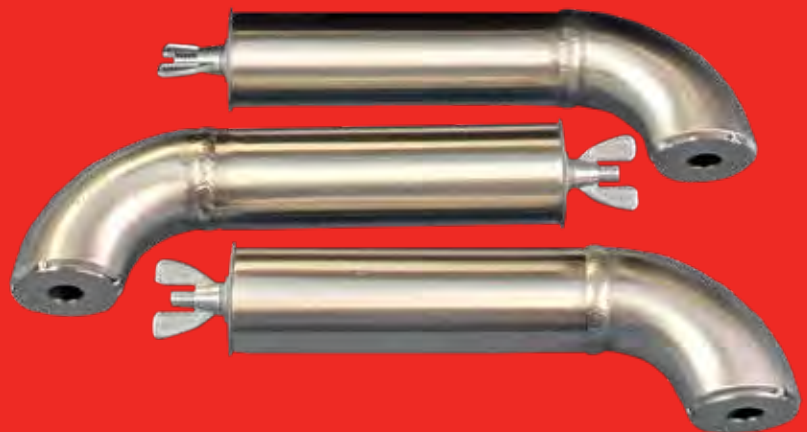

#EPRI-K1

BOILER TUBE DAMAGE KIT

Designed and Manufactured to Replicate Field Removed Specimens

KIT CONTAINS

19 BOILER TUBES:

- Representing a complete range of fossil-fired boiler tube failure mechanisms steam and water touched.

TUBE SPECIFICATIONS:

- 18 Tubes At 2.5" OD X 0.25" Wall X 8" Long
- 1 Tube At 1.5" X 0.25" Wall X 8" Long

MATERIAL

- 17 Tubes are SA513 T5 GR 1020/1026 CS
- 1 Tube is 304/304L
- 1 Dissimilar metal weld

FLAWS / INDICATIONS

- Long term overheating/creep
- Fire side corrosion (coal)
- Toe crack, stress corrosion (stainless)
- Soot blower erosion
- Fatigue crack (toe)
- Maintenance damage
- Pitting
- Rubbing / Fretting
- Chemical cleaning damage (thinning & pitting)
- Material flaw (forging lap)
- Corrosion fatigue crack
- Fly ash erosion, Hydrogen damage
- Acid Phosphate corrosion
- Caustic gouging
- Supercritical waterwall cracking (1.5" OD tube)
- Weld defects (lack of fusion and porosity)
- Graphitization

EPRI Program 63 Members Receive a Special Discount.

Use This Kit To Assist In The Training And Qualifying Of NDE Technicians To Accurately Identify Specific Boiler Tube Damage Found In Fossil Plants.

Carrying Case: Included (Rolling and Lockable)



OFFICIALLY APPROVED BY **EPRI** | ELECTRIC POWER RESEARCH INSTITUTE

#A7-K1 ASME SECTION XI APPENDIX VII KIT

8 piece specimen set

Contains 20 "real flaws"

For Training and Qualification

2 - WELDED PLATES

- (1) CARBON STEEL PLATE: #A7-CS-005
 - (1) STAINLESS PLATE: #A7-SS-005
- 0.5" X 10" X 12"

2 - WELDED PLATES

- (1) CARBON STEEL PLATE: #A7-CS-010
 - (1) STAINLESS PLATE: #A7-SS-010
- 1.0" X 10" X 12"

1 - WELDED PIPE

- (1) STAINLESS PIPE: #A7-SS-020
- 2" SCH160 X 12"

1 - WELDED PIPE

- (1) CARBON STEEL PIPE: #A7-CS-040
- 4" SCH160 X 12"

1 - WELDED PIPE

- (1) STAINLESS PIPE: #A7-SS-060
- 6" SCH160 X 12"

1 - WELDED PIPE

- (1) CARBON STEEL PIPE: #A7-CS-100
- (180° SEGMENT)
10" SCH160 X 12"

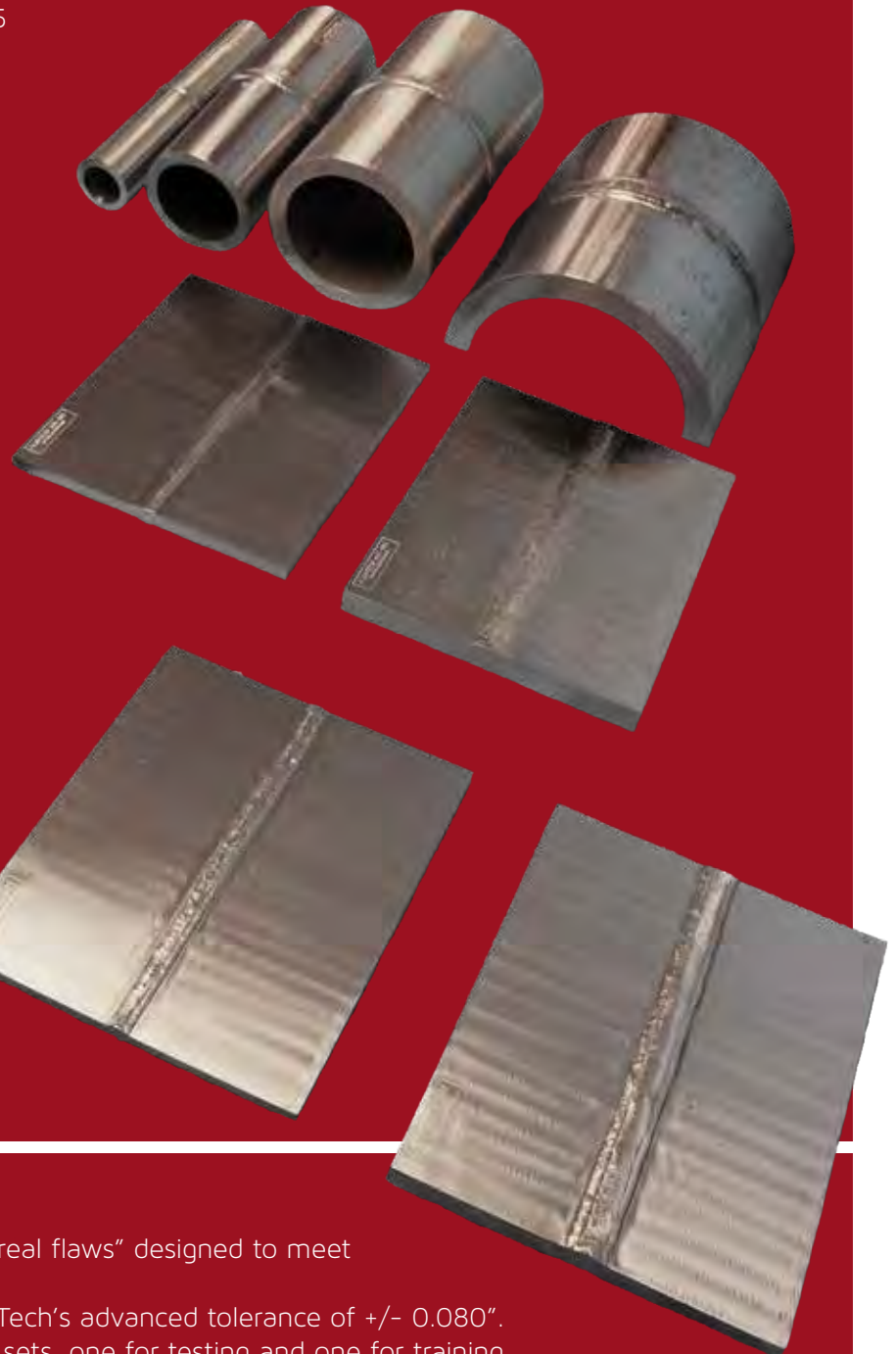

KIT SPECIFICATIONS

- Each specimen contains two to four "real flaws" designed to meet appendix VII specifications.
- Specimens are manufactured to FlawTech's advanced tolerance of +/- 0.080".
- No two specimens are alike. Buy two sets, one for testing and one for training.
- Document package includes CAD drawings, certificates of conformance, and NDT reports.
- Custom options available such as 10% notches, blank specimens, and the purchase of individual flawed specimens. Contact FlawTech for more details.

ASME SECTION XI APPENDIX VIII KITS

ASME BOILER & PRESSURE VESSEL CODE, SECTION XI, APPENDIX VIII, SUPPLEMENTS 2, 3 & 10 KITS

#S2-K1

SUPPLEMENT 2 KIT FOR
AUSTENITIC PIPING
360 lbs

PIPE SPECIMEN DIMENSIONS	UNFLAWED UNITS	FLAWED UNITS
2" SCH80 X 24" 360°	1	1
4" SCH80 X 24" 360°	3	1
6" SCH160 X 24" 360°	4	2
12" SCH80s X 24" 360°	9	3
24" SCH80s X 24" 120°	5	3
KIT TOTAL - 5 SPECIMENS	22	10

#S3-K1

SUPPLEMENT 3 KIT FOR
FERRITIC PIPING
350 lbs

PIPE SPECIMEN DIMENSIONS	UNFLAWED UNITS	FLAWED UNITS
2" SCH80 X 24" 360°	1	1
4" SCH80 X 24" 360°	3	1
6" SCH160 X 24" 360°	4	2
12" SCH80s X 24" 360°	9	3
24" SCH80s X 24" 120°	5	3
KIT TOTAL - 5 SPECIMENS	22	10

#S10-K1

SUPPLEMENT 10 KIT FOR
DISSIMILAR METAL WELDS
340 lbs

PIPE SPECIMEN DIMENSIONS	UNFLAWED UNITS	FLAWED UNITS
4" SCH80 X 24" 360°	1	2
6" SCH160 X 24" 360°	3	2
8" SCH80 X 24" 360°	4	3
12" SCH80s X 24" 180°	9	4
24" SCH80s X 24" 90°	5	4
KIT TOTAL - 5 SPECIMENS	22	15

KIT AND FLAW DETAILS:

- The kits are manufactured to meet the minimum requirements of ASME, boiler & pressure code, Section XI, Appendix VIII, of Supplements 2, 3 & 10
- At least 50% of the cracks will be coincident with fabricated conditions such as: ground & AS-welded crowns, counterbores & weld root conditions.
- Flaw depths will range from the 10-30% through the 61 - 100% depth ranges as in ASME section XI, appendix VIII.
- All the flaws will be mechanical fatigue or thermal fatigue cracks, with at least 75% of the cracks being thermal fatigue.
- Kits made to our critical tolerance $\pm 0.040"$ (1MM).
- Custom appendix VIII specimens are available.
- Contact FlawTech for more details.

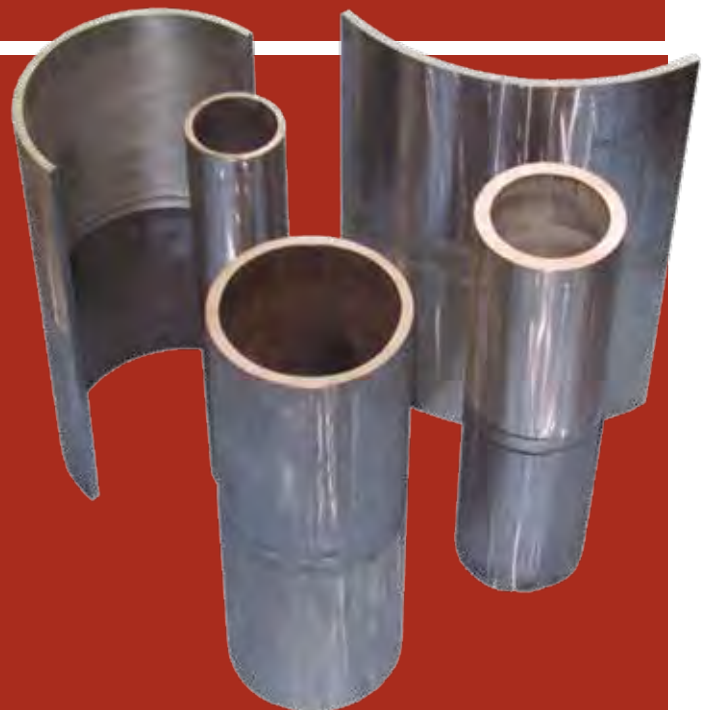

#EISHIN-10, #EISHIN-20, #EISHIN-30, #EISHIN-50

EISHIN NiCr TWIN CRACKED PENETRANT TEST PANELS

Eishin reference blocks meet the requirements of:

- ASTM E1417, AMS 2647D, ISO 3452-3, JIS Z 2343-3

Specifications:

- These panels are used for comparing and evaluating sensitivity and performance of Dye Penetrants.
- Each set consists of a pair of identical panels marked A and B.
- Available in 10, 20, 30, 50 microns (0.0004, 0.0008, 0.0012, 0.002 inch)

Documentation:

- A certificate of Conformance and a Crack Photograph



ALUMINUM PENETRANT COMPARATOR BLOCK

#APC-1

The test block meets the following specifications:

- ASME Section V, Article 6, Appendix III
- ASTM E1417/E1417M-13, Sections 7.8.3.3 & 7.8.3.4
- MIL-I-25135 C

This Block has many names:

- Quench Crack Block
- Cracked Aluminum Block
- Penetrant Comparator Block

Material:

- 2024 Aluminum
- 3/8¹/₄x 3.0¹/₄x 2.0¹/₄

Specifications:

- Block contains a machined groove on either side of the block that splits the face in half. These halves are identified with an "A" and "B"

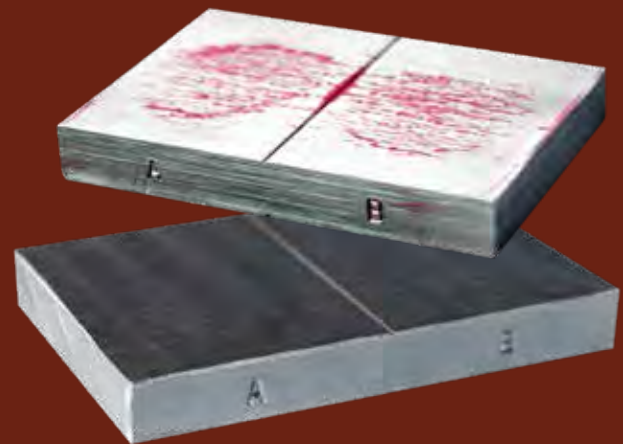

FlawTech does not cut the blocks in half as described in the ASME code
These blocks may be cut in half and marked as a mating pair at an additional cost
Note: These blocks are not intended for multiple uses

Documentation:

- Certificate of Conformance and Material Test Reports with each block.

UT CALIBRATION BLOCKS

ASTW

AWS

Navships

FBH

Sensitivity

IIW

Stepwedges

Angle Beam

Phased Array

Distance Amplitude

Resolution Block

Metric Or Standard

Custom

Type 1 #IIW-T1-1
Metric: #IIW-T1-1M



Type 2 #IIW-T2-1
Metric: #IIW-T2-1M



V1/5 (A2)
#IIW-V1-1



5 Step #5S-CB-1



4 Step #4S-CB-1



Custom Step Blocks



DC Block
#DC-CB-1



Resolution Block (RC)
#RC-CB-1



DSC Block #DSB-CB-1
Metric: #DSB-CB-1M



DS Block #DS-CB-1



Set of 8
#DA-S8-1



Set of 10
#DA-S10-1



Set of 19
#DA-S19-1



Mini Angle Beam Block
#MAB-CB-1



"PACS" Phased Array Test Block
#PACS-1



V2 (A4) Cal Block
#V2-CB-1

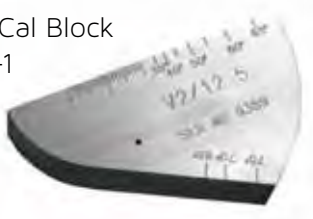

ISO 7963 Test Block #2
#ISO-TB-2



PDI UT CALIBRATION BLOCKS

PDI ALTERNATIVE ASME CALIBRATION BLOCKS

The PDI Alternative ASME blocks meet the requirements of the Performance Demonstration Initiative (PDI) Procedure No. PDI-UT-1, Rev. C, Fig. 4(Ferritic) and PDI-UT-2, Rev. C, Fig.4(Austenitic).

These blocks cover the generic procedures for the ultrasonic examination of both ferritic and austenitic pipe welds.

The blocks offer users an economical alternative to fabricating multiple curved cal blocks (pipe sections) in many diameters and wall thicknesses.

The blocks are normally supplied in sets of 3 individual blocks; A516 Grade 70 Carbon Steel, Type 304/304L Stainless Steel, and also in Type 316/316L Stainless Steel. Individual blocks of any one alloy may also be purchased. The blocks are made from ultrasonically inspected, heat number- traceable material.

The block design consists of four (4) steps (representing wall thicknesses) measuring 0.5", 1.0", 1.5", and 2.0". Each step contains an EDM notch machined to a depth of 10% of wall x .010" wide x 2.0" long. Overall block size is 2.00" wide x 2.25" tall x 10.00" long.

The scanning and reflecting surfaces are intentionally machined to simulate pipe and plate surfaces of 250 Ra maximum finish. Each block is permanently machine-engraved on one edge to include the block description, serial number, alloy, and heat number.

Contact FlawTech for all your Standard and Custom Calibration Block Needs.
All materials available upon request.

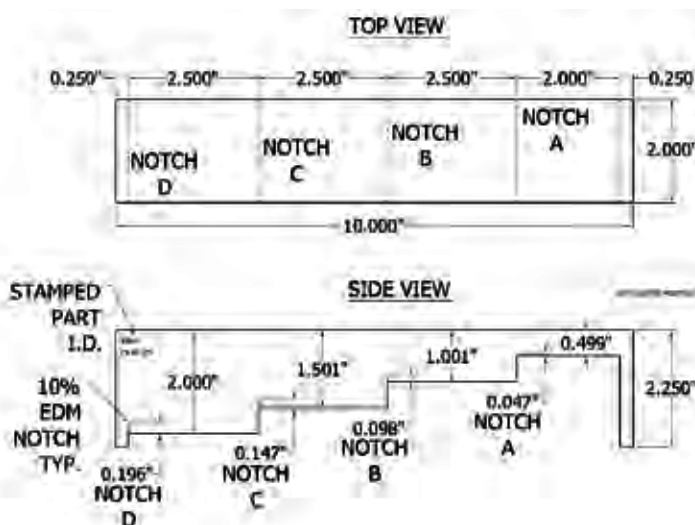

ASME UT CALIBRATION STANDARDS

ASME SEC. V BASIC CALIBRATION BLOCKS

The block is used for establishment of primary reference responses for UT examination welds. Block contains three (3) DAC side drilled holes at 1.5" deep minimum at diameters between 0.0937" and 0.25" depending on the block thickness (T). Hole locations through the thickness are 1/4, 1/2, and 3/4 T. The block will also have two (2) notches measuring 2% (T) deep x 1.0" long minimum. Specification: ASME Section V, Article 4, Figure T-434.2.1. Dimensions: T x 6.25" x 3 (T) minimum. Block is available in normal thicknesses of 0.5", 1.5", 3" and 5".



ASME SEC. V ANGLE BEAM CALIBRATION BLOCKS

The basic calibration block for weldments shall be a section of pipe of the same normal size, schedule, heat treatment and material specification as the material being examined. Standard will contain four (4) notches, two (2) longitudinal and two (2) circumferential on both the OD and ID at a target depth of 9.5% of nominal wall thickness and a minimum of 1" long. FlawTech can provide the material or use customer furnished material. In accordance with ASME Sec V, Article 4, Figure T-434.3 (Calibration Block for Pipe.)

FlawTech offers ASME Calibration Standards in any commercially available pipe size or plate thickness. Custom options are also available. Contact FlawTech for more information.



PDI UT 10 CALIBRATION STANDARDS

PDI CONTOURED CALIBRATION BLOCKS FOR DISSIMILAR METAL (DM) WELDS

Contoured calibration blocks are used in the manual examination of dissimilar metal (DM) welds and base materials including piping susceptible to Stress Corrosion Cracking (SCC). The blocks are used to establish a reference sensitivity level from which subsequent exams may be compared. The blocks are precisely machined to fit contoured search units for axial and circumferential scanning directions. Customer specifies block contour radius based on diameter of material being inspected. Blocks are manufactured in Type 304 or Type 316 Stainless Steel and are certified to meet Performance Demonstration Initiative PDI-UT-10 and PDI-UT-8.

Contact FlawTech for all your Standard and Custom Calibration Block Needs.

All materials available upon request.



NOTES

Contact *FlawTech* www.FlawTech.com TEL: 704.795.4401 FAX: 704.795.4403

FLAWTECH



Veteran Owned & Operated



R. B. M. Ltd.
CONTROL & MECHANIZATION

www.rbmltd.co.il 09-7674431:טל
rbmltd@rbmltd.co.il כפר סבא